

Installationsanleitung FiberDose für FTTH
Installation guide FiberOutlet for FTTH
Instructions de montage boîtier fibre pour FTTH

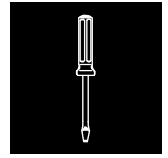

021.1431

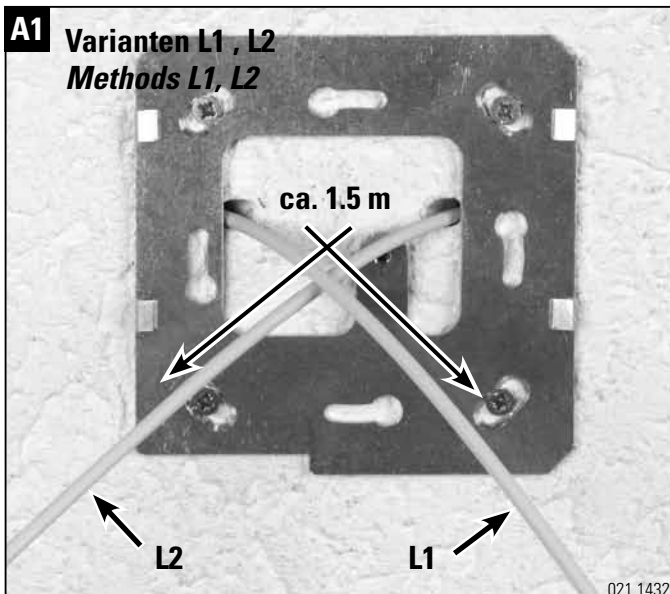

021.1432

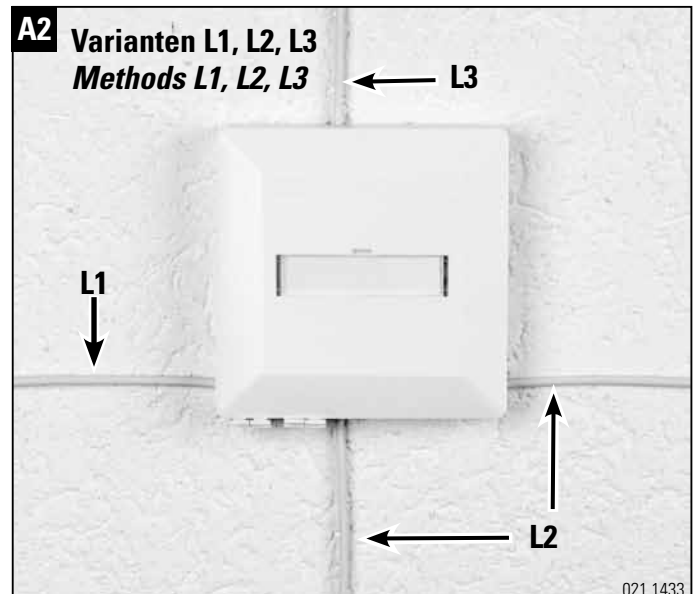

021.1433

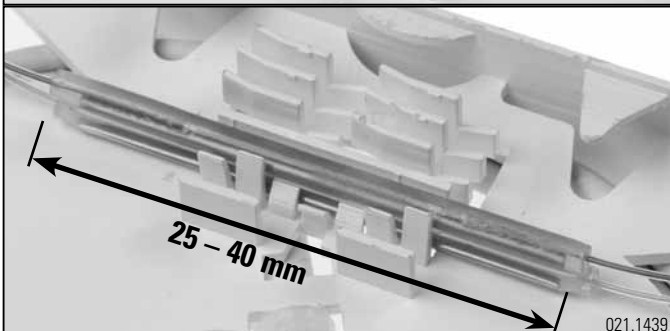
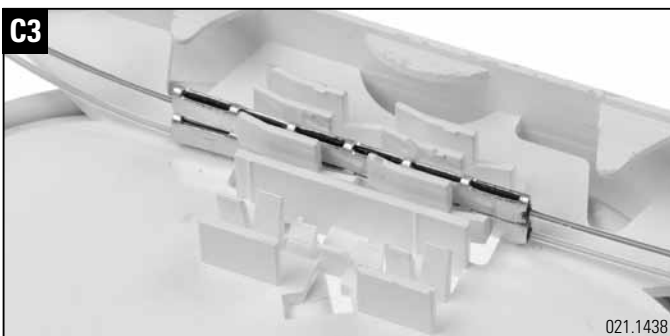
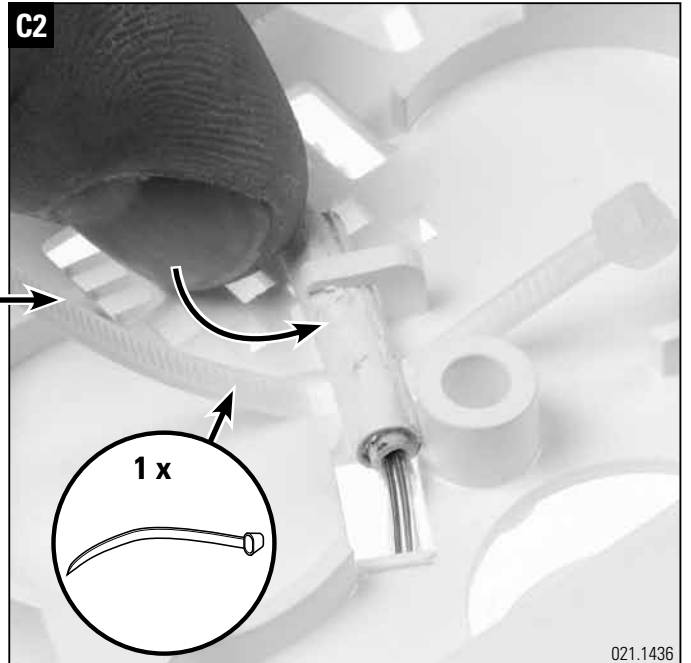
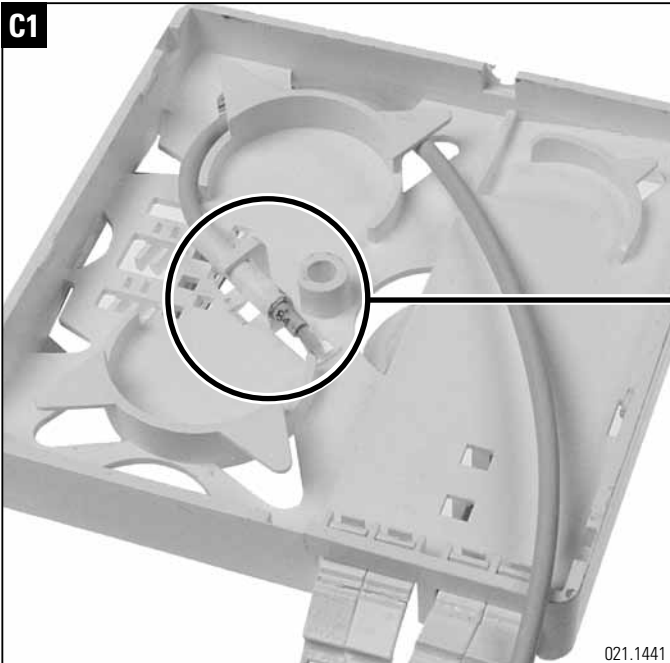
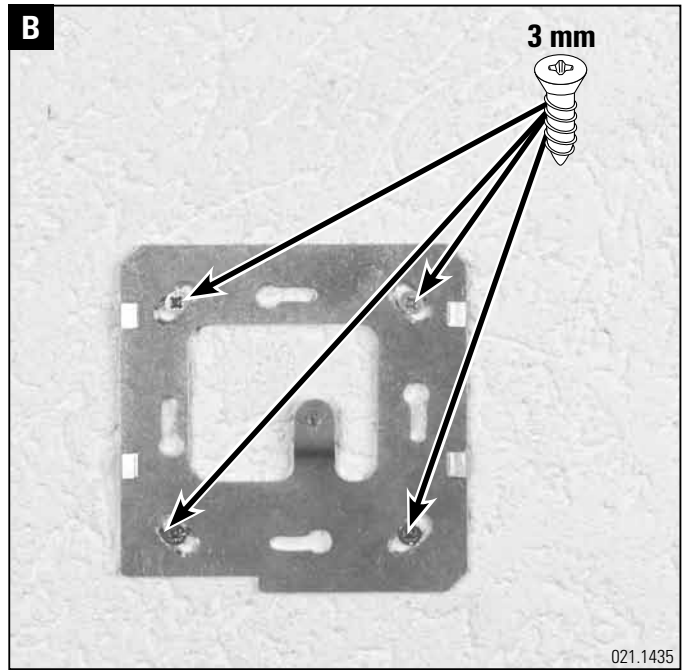
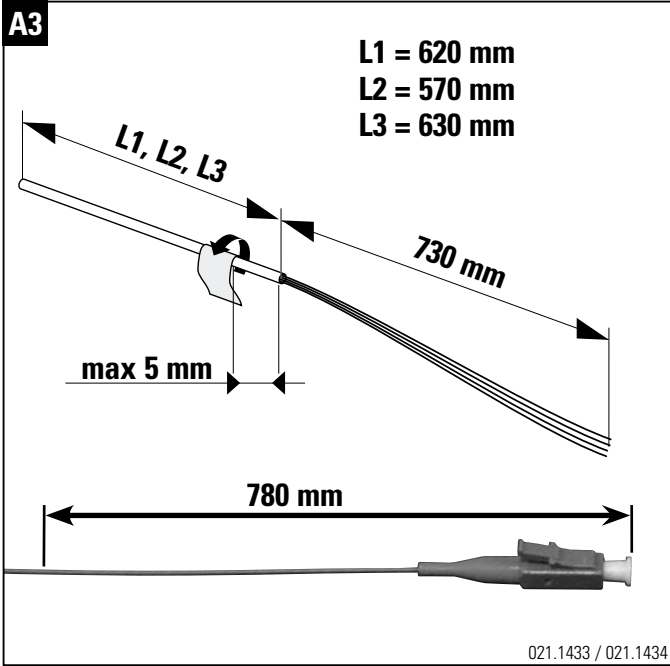

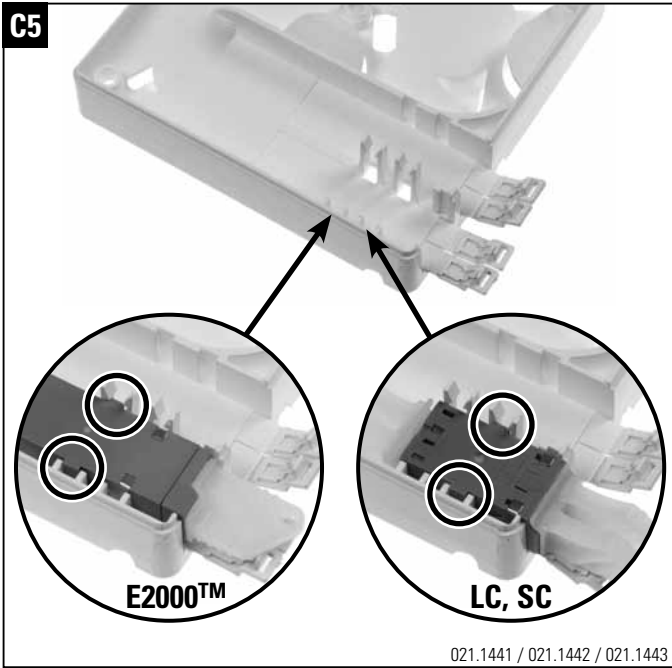

021.1441 / 021.1442 / 021.1443



021.1440

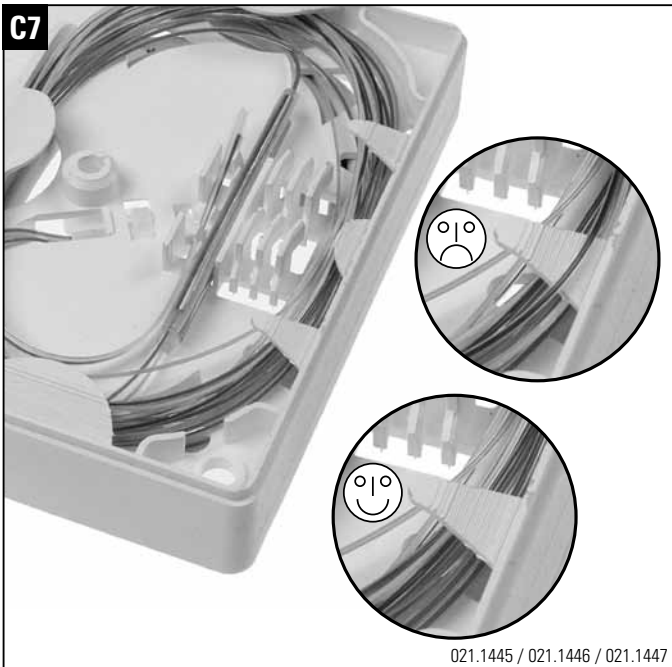

021.1445 / 021.1446 / 021.1447



021.1448

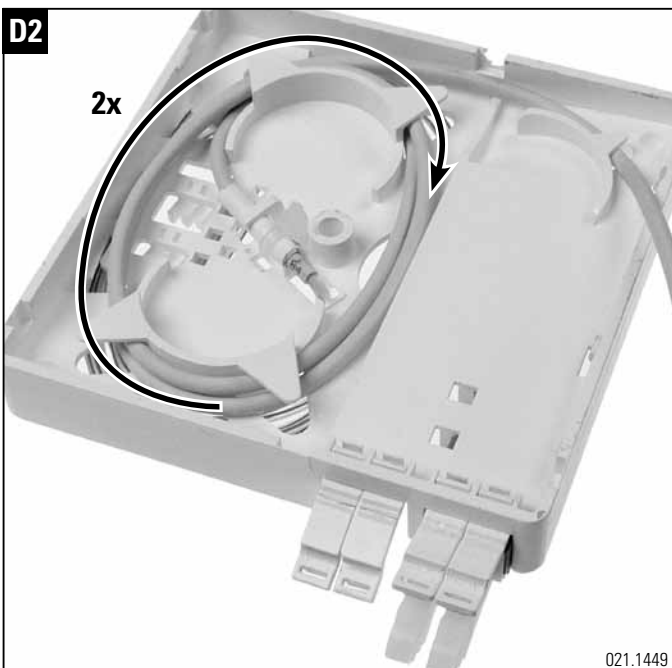

021.1449



021.1450

D4 Bei Varianten L3
with method L3



021.1451

E1

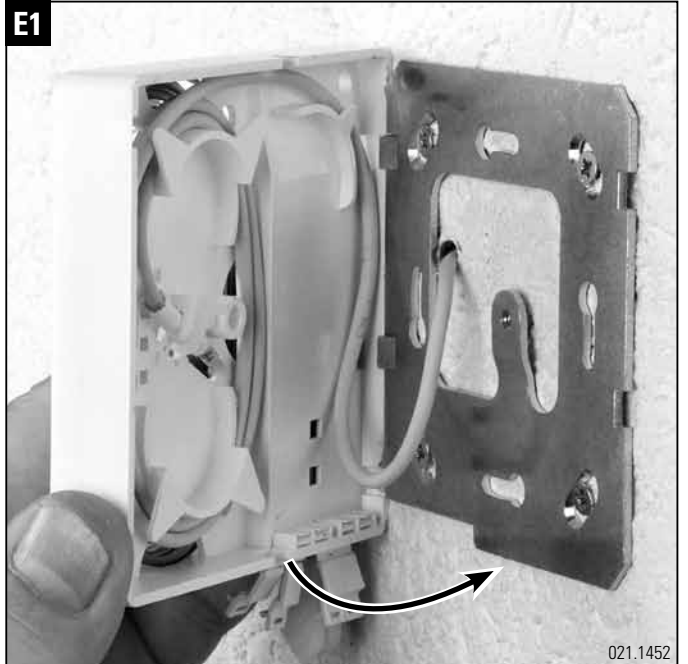

021.1452

E2 Demontage

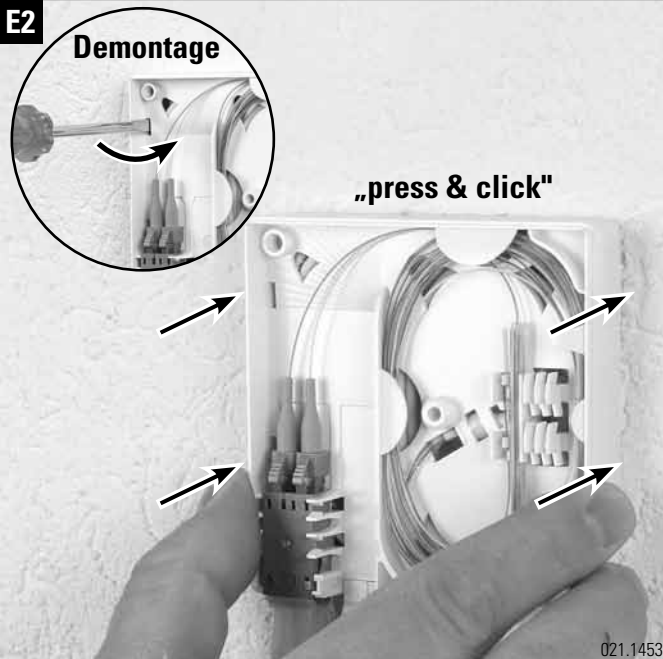

021.1453

E3

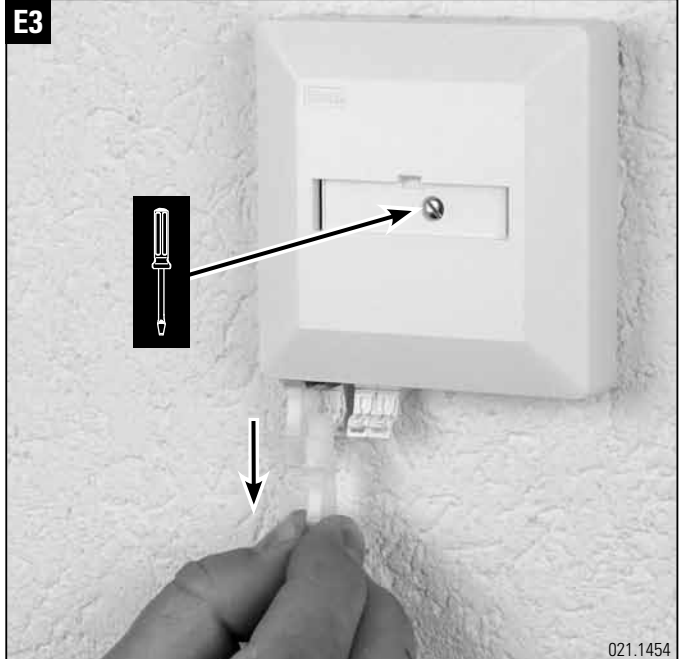

021.1454

E4

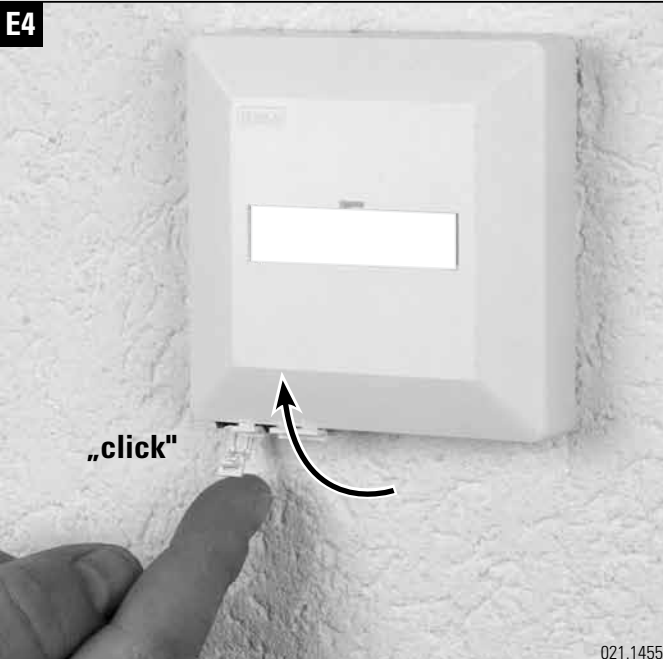

021.1455

Headquarters

Switzerland

Reichle & De-Massari AG

Binzstrasse 32

CHE-8620 Wetzikon

Telephone HQ +41 (0)44 933 81 11

Telefax HQ +41 (0)44 930 49 41

E-Mail hq@rdm.com

www.rdm.com

R&M