

**KombiMODUL - links**  
**CombiMODULE - left**



021.3223

**KombiMODUL - rechts**  
**CombiMODULE - right**



021.3233

**SpleissMODUL**  
**SpliceMODULE**



021.3240

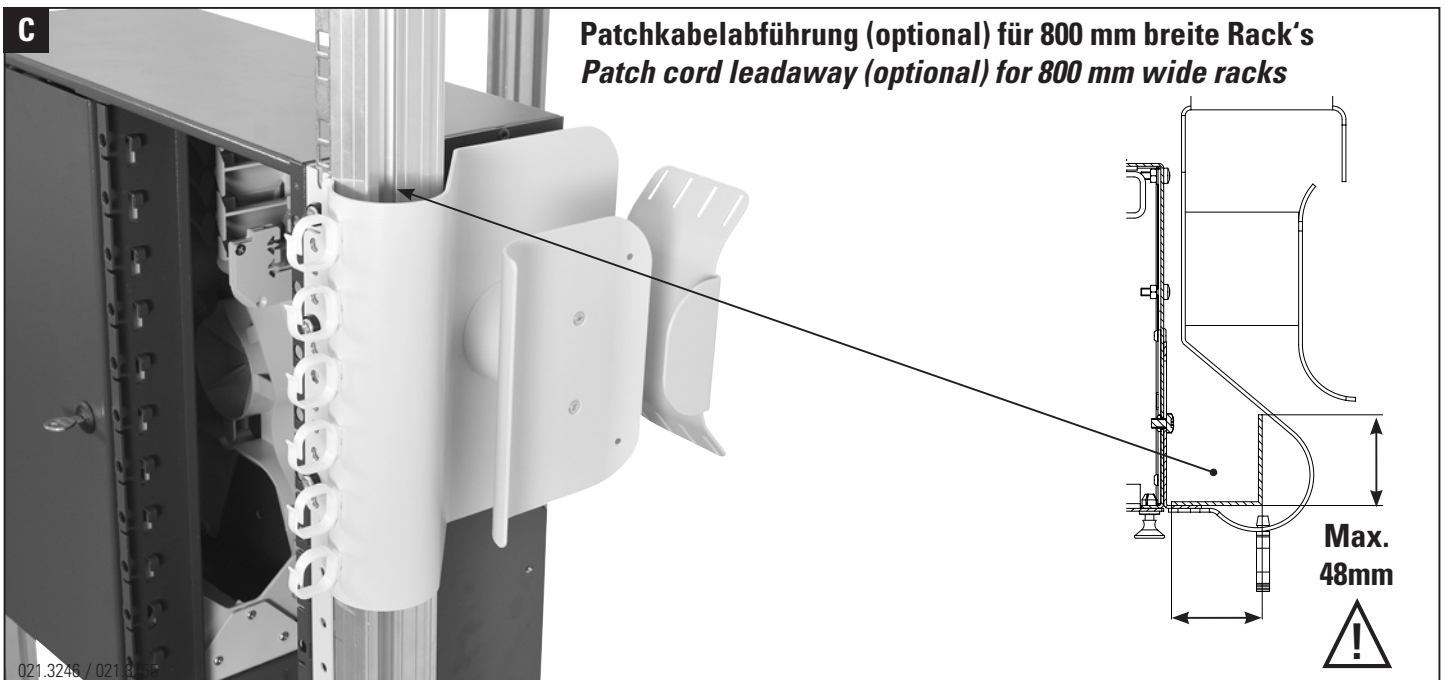
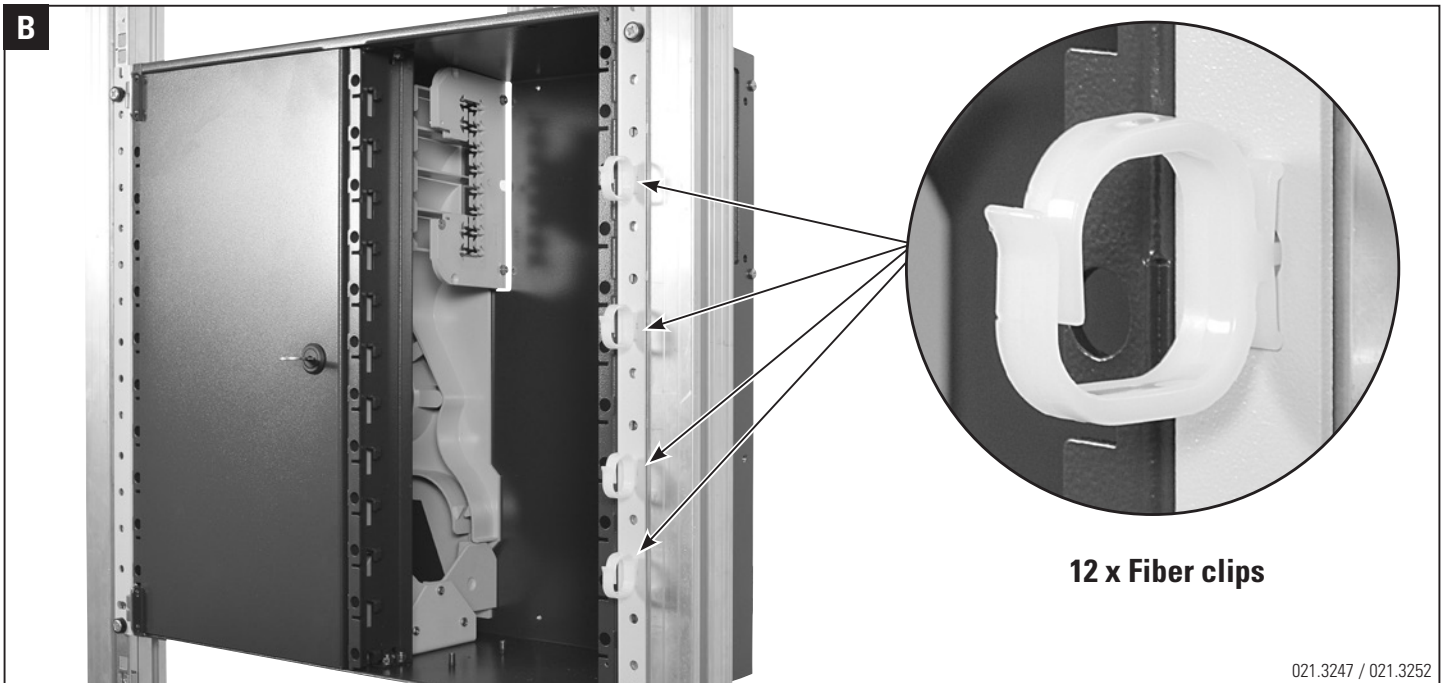
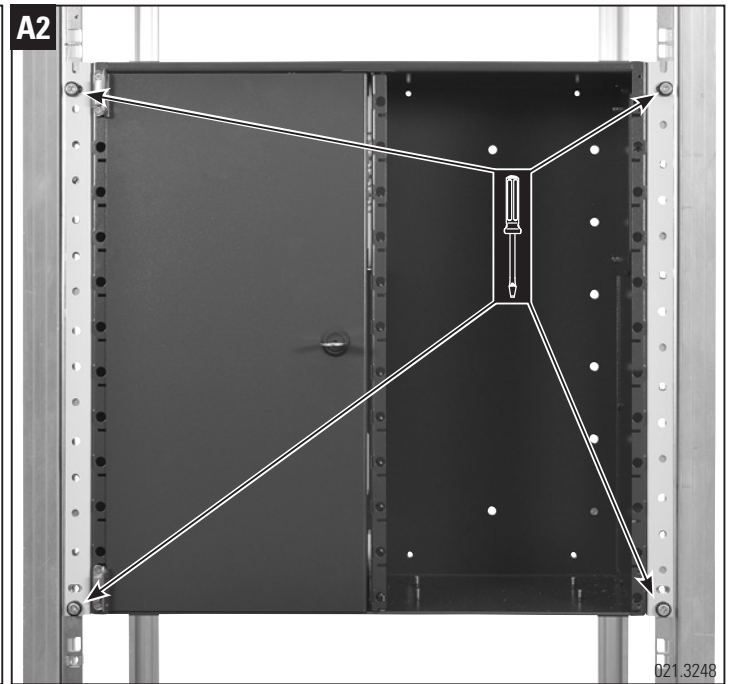
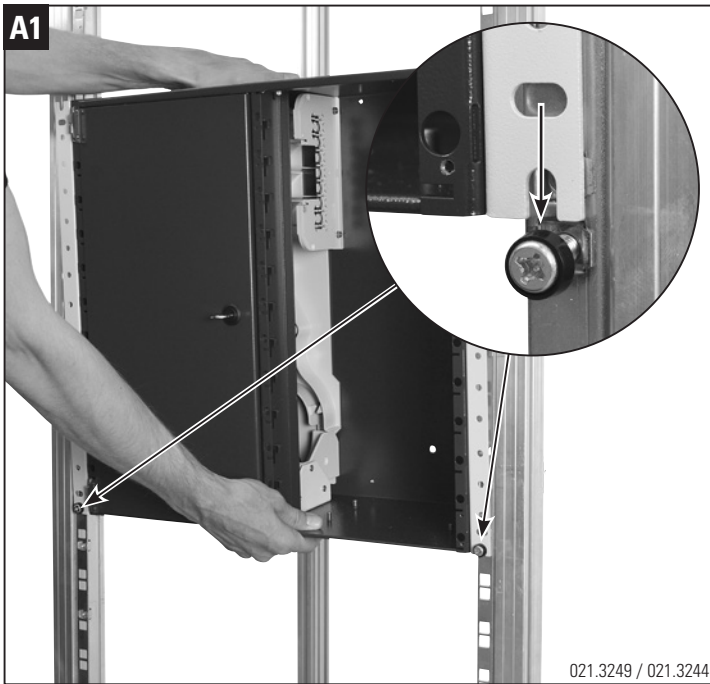

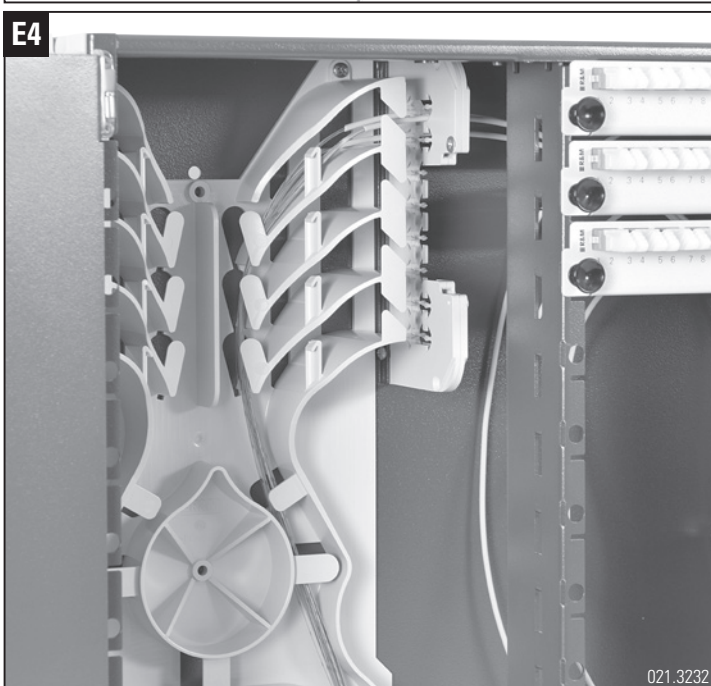
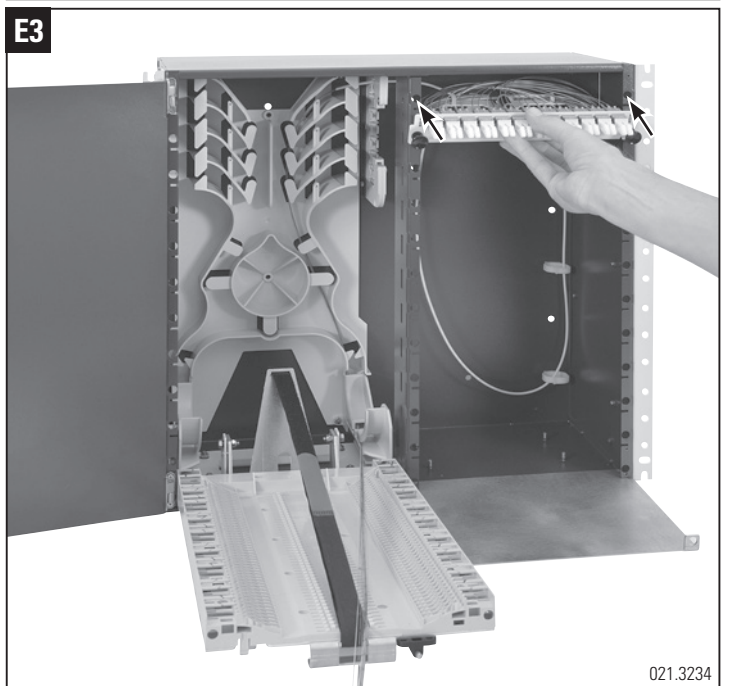
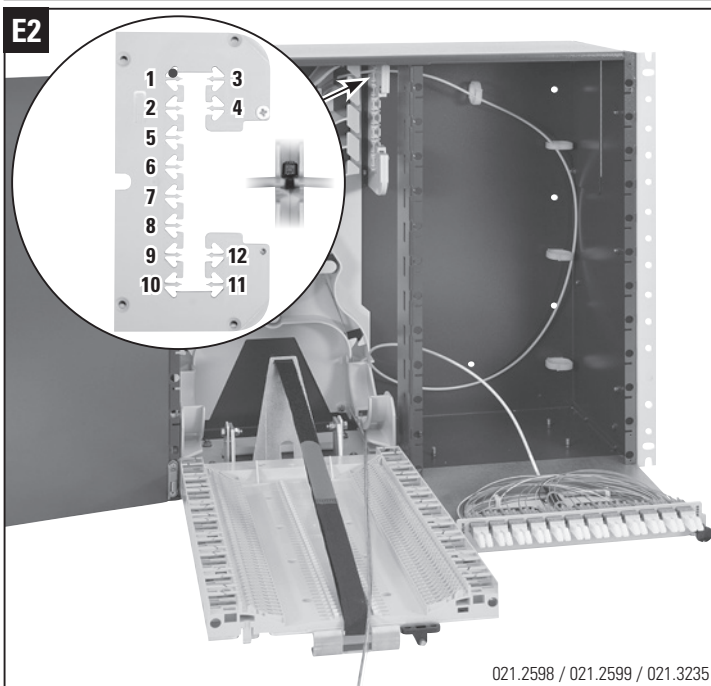
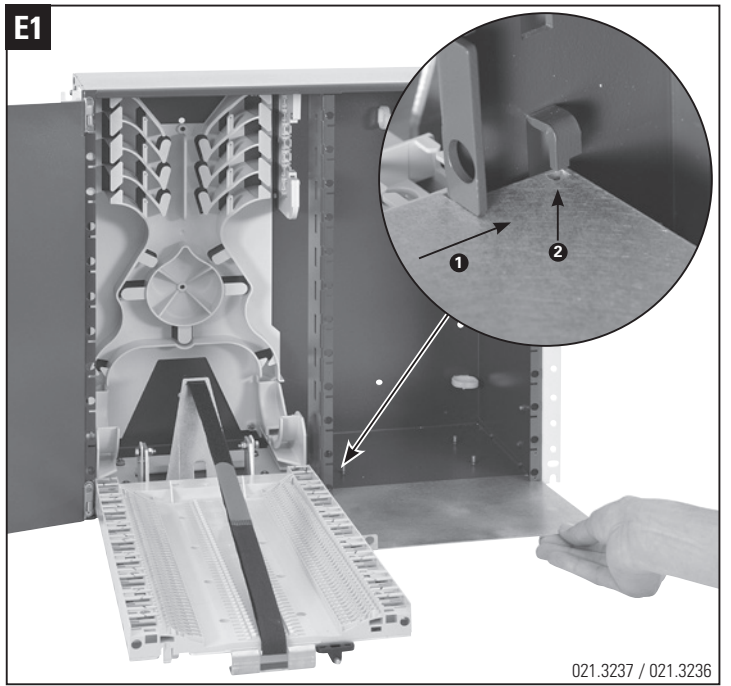
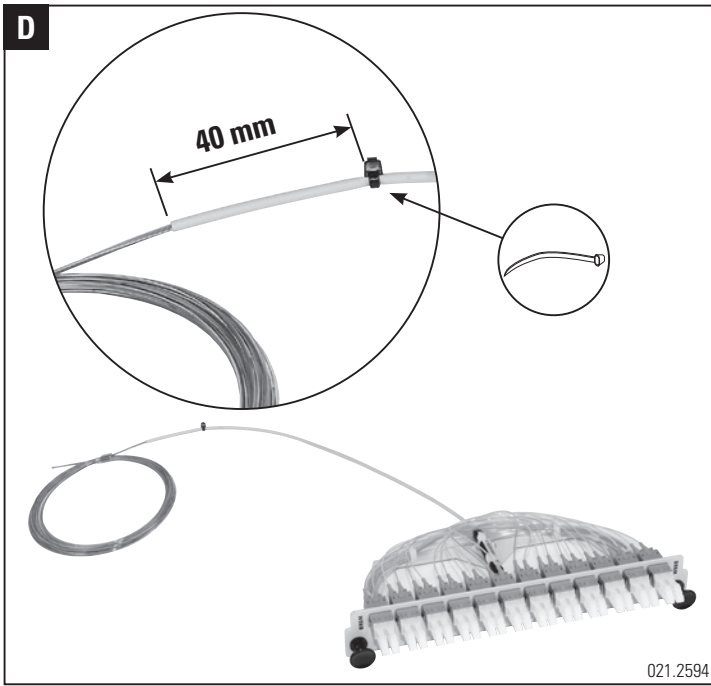

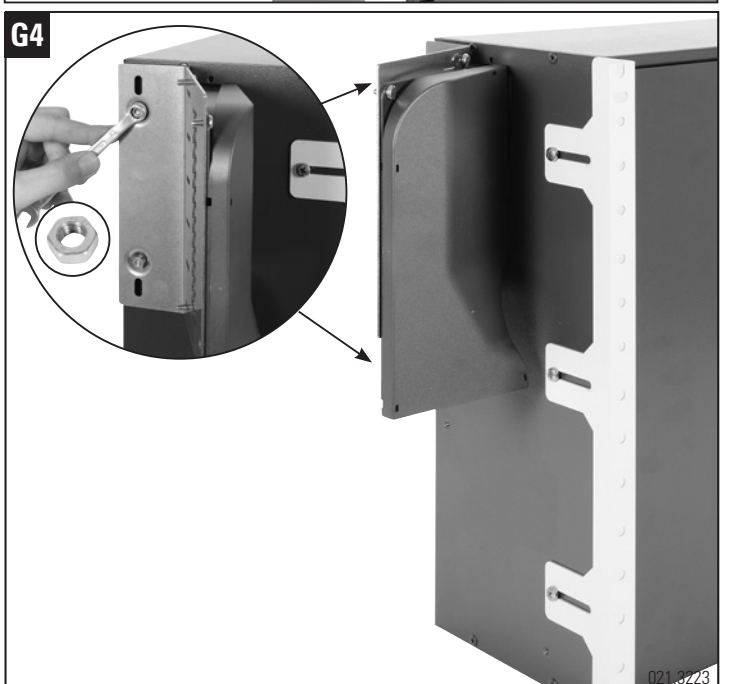
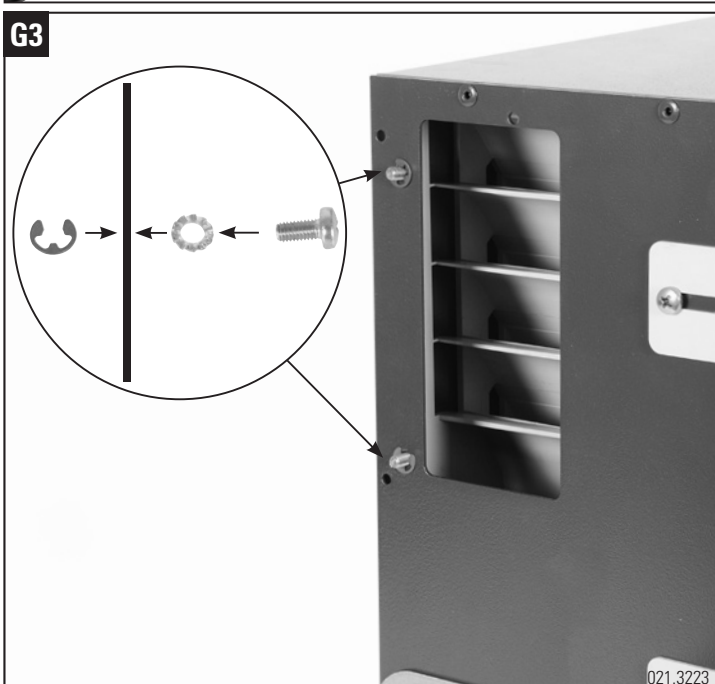
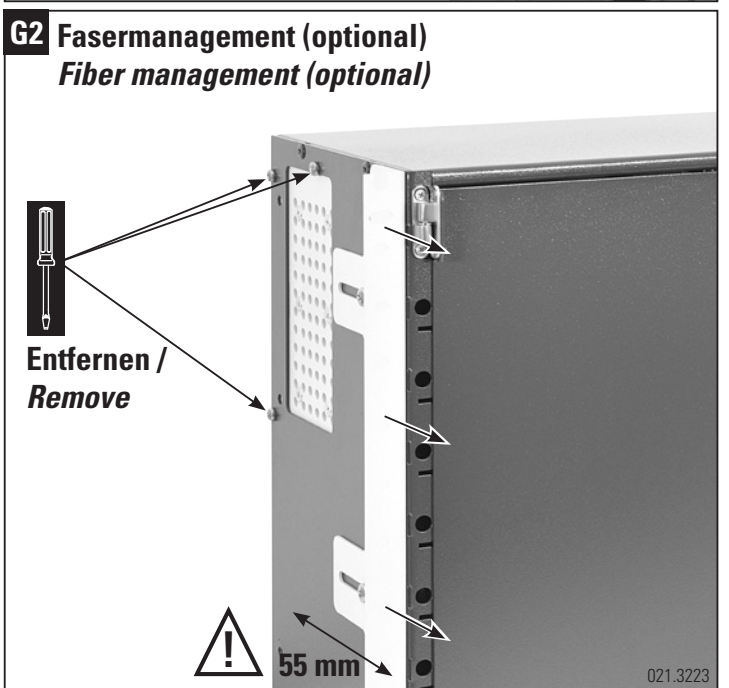
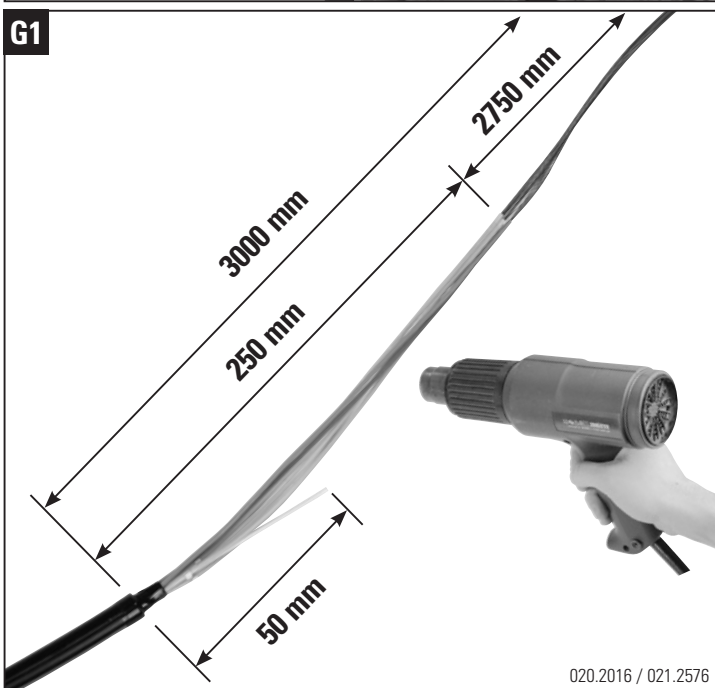
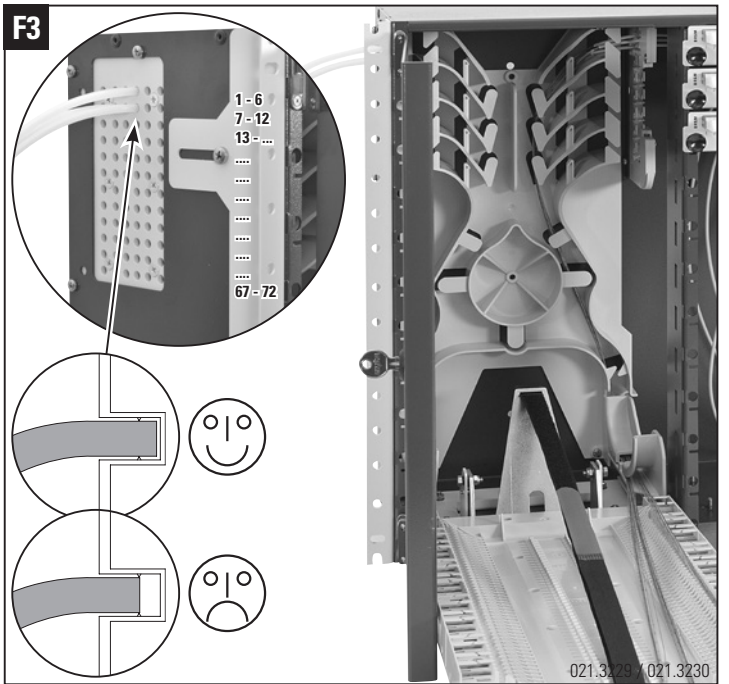
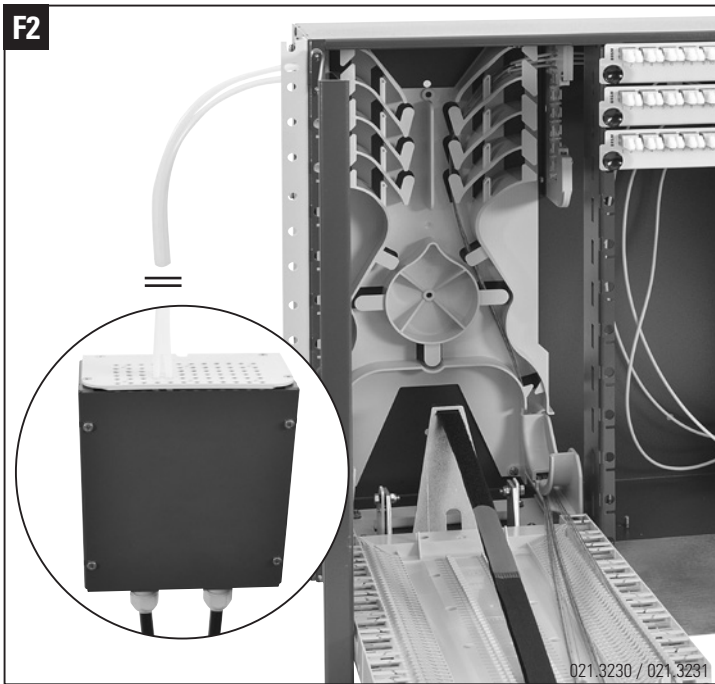

G5

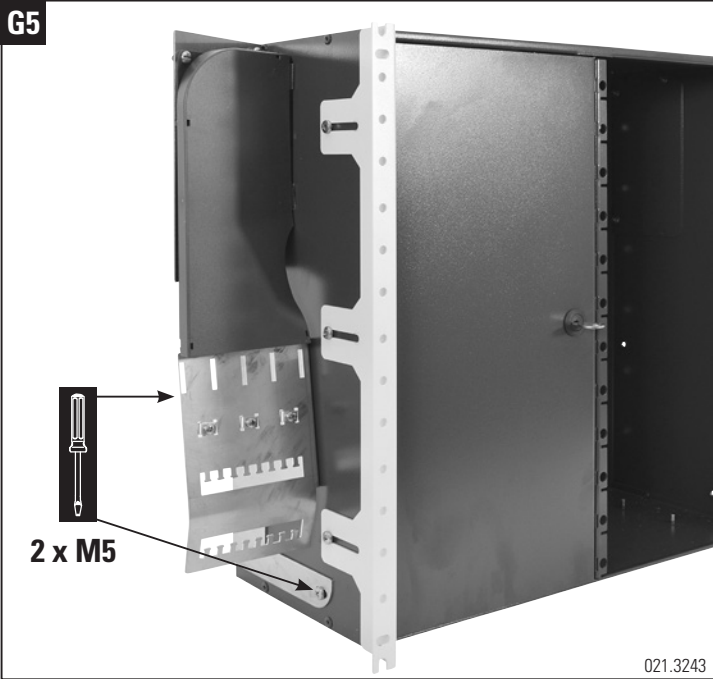

021.3243

H Faserführung / Fiber routing

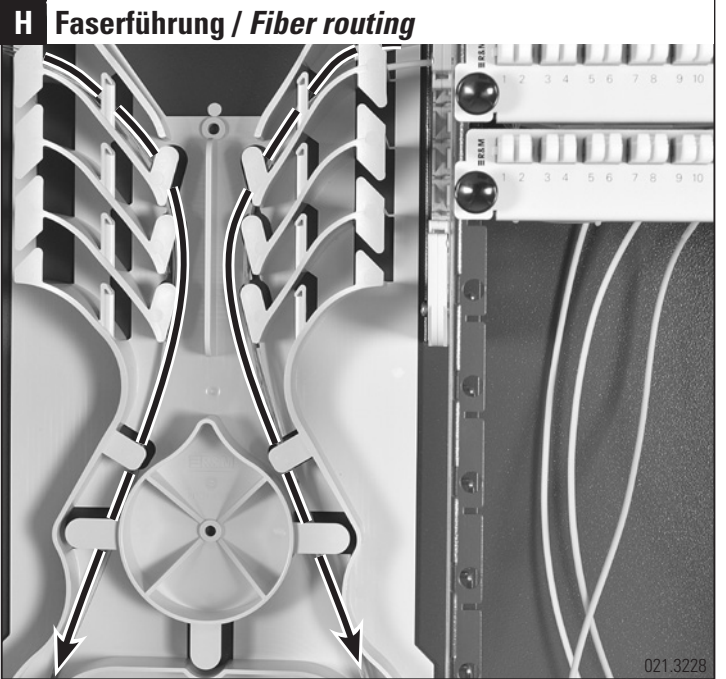

021.3228

I1

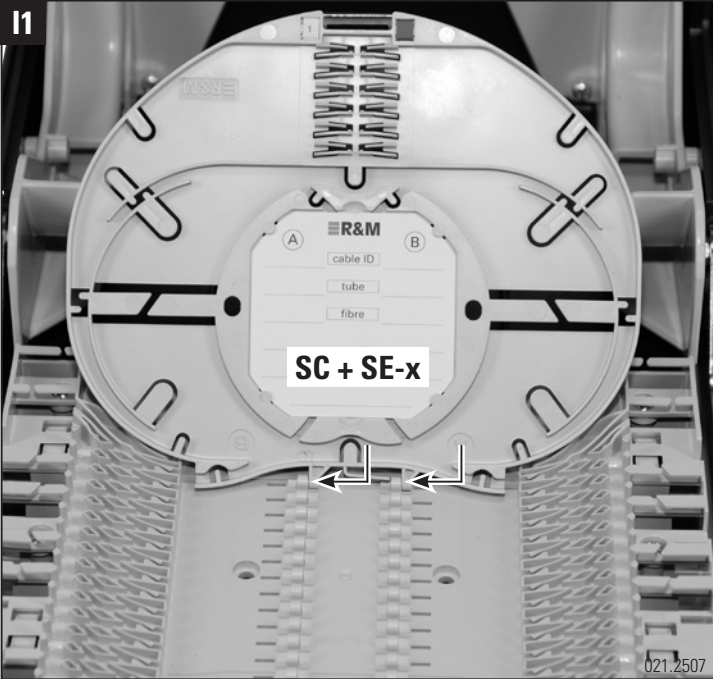

021.2507

I2

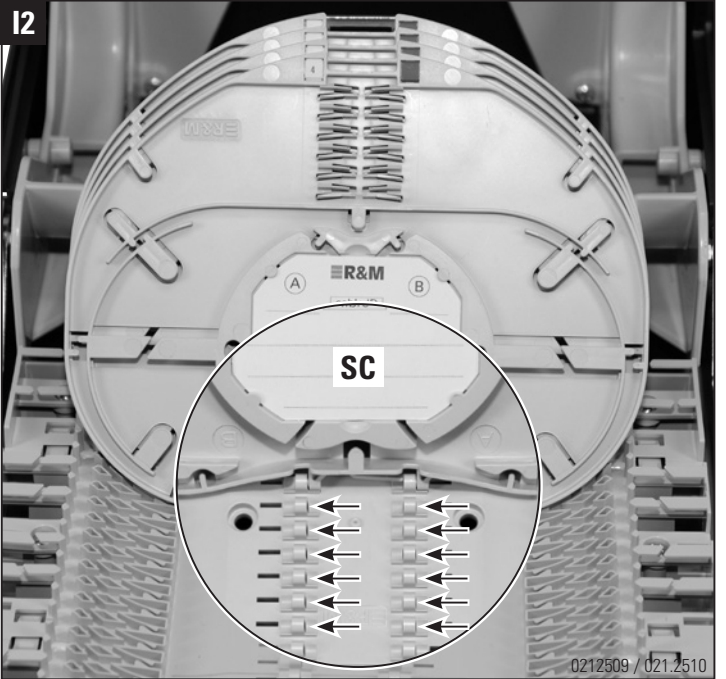

0212509 / 021.2510

I3



021.2508 / 021.2510

I4

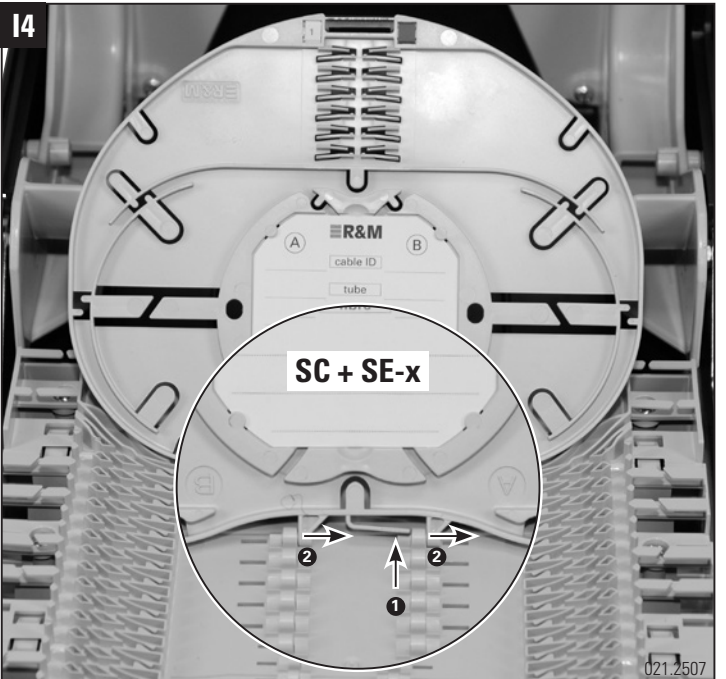

021.2507

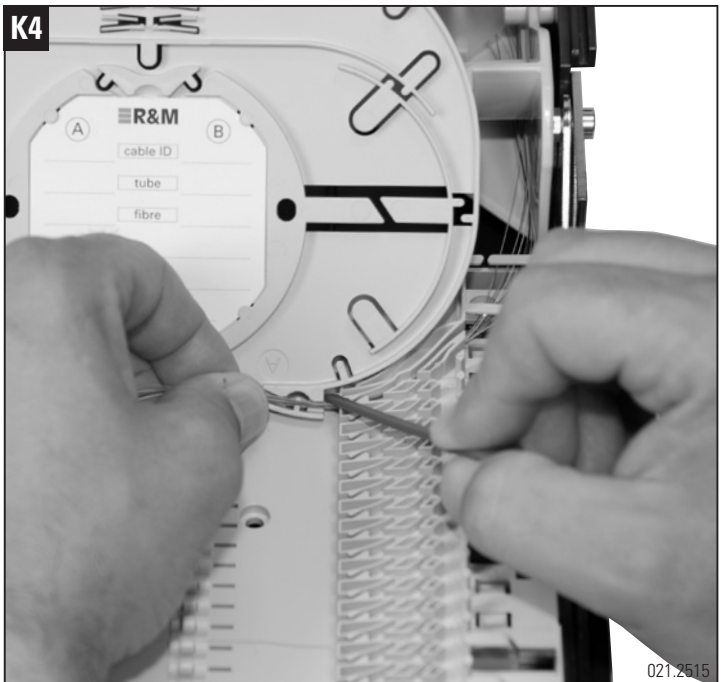
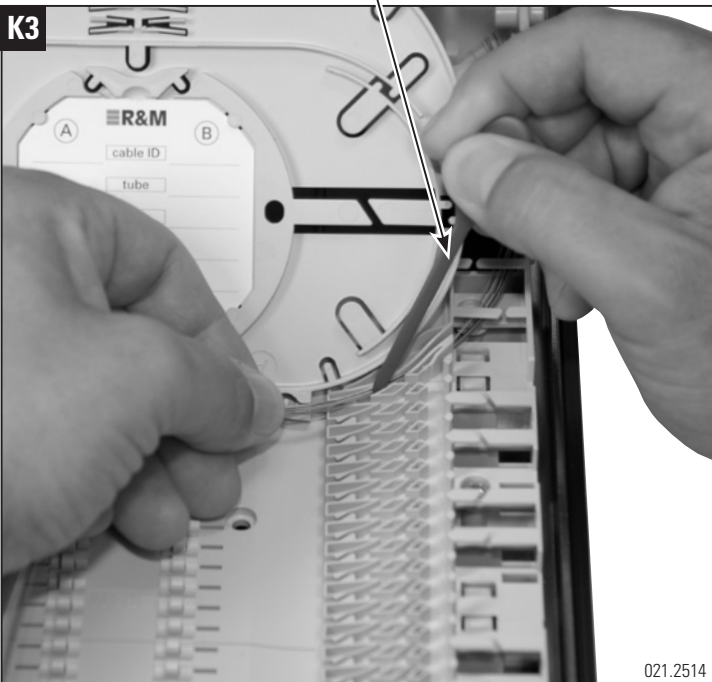
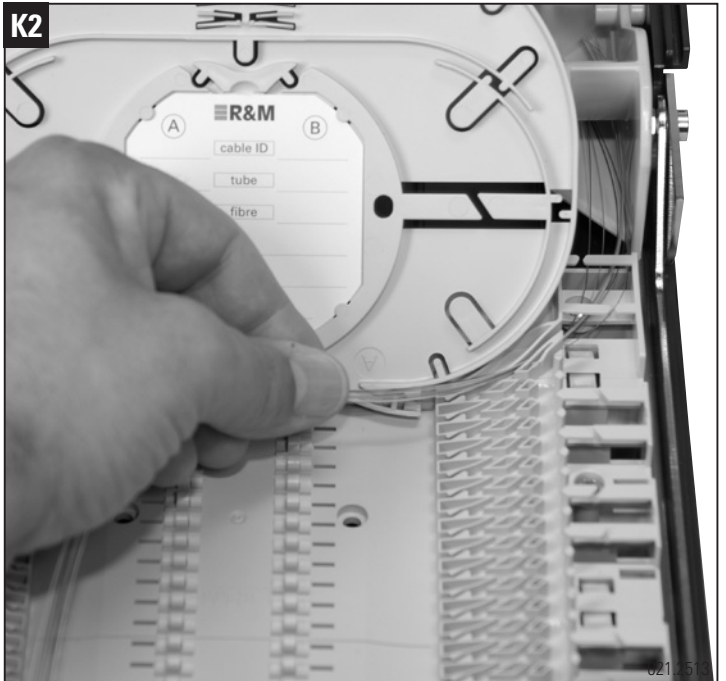
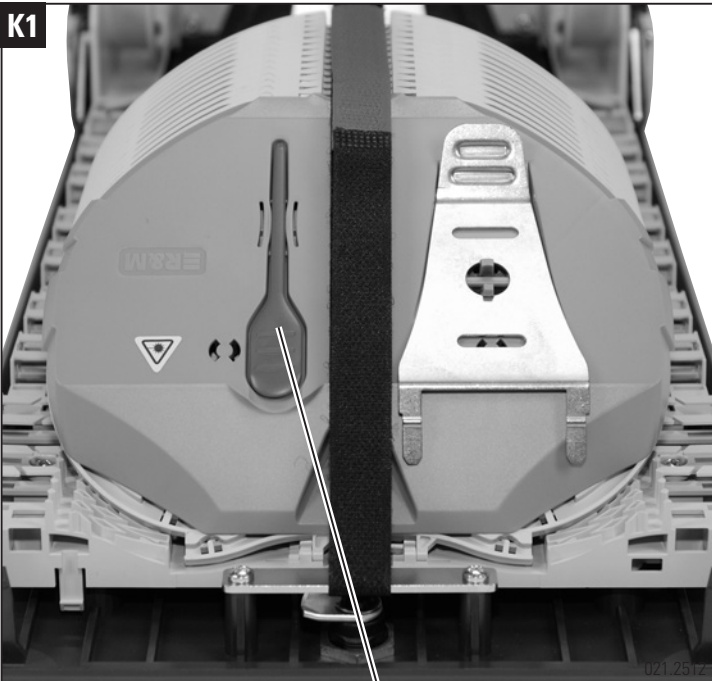
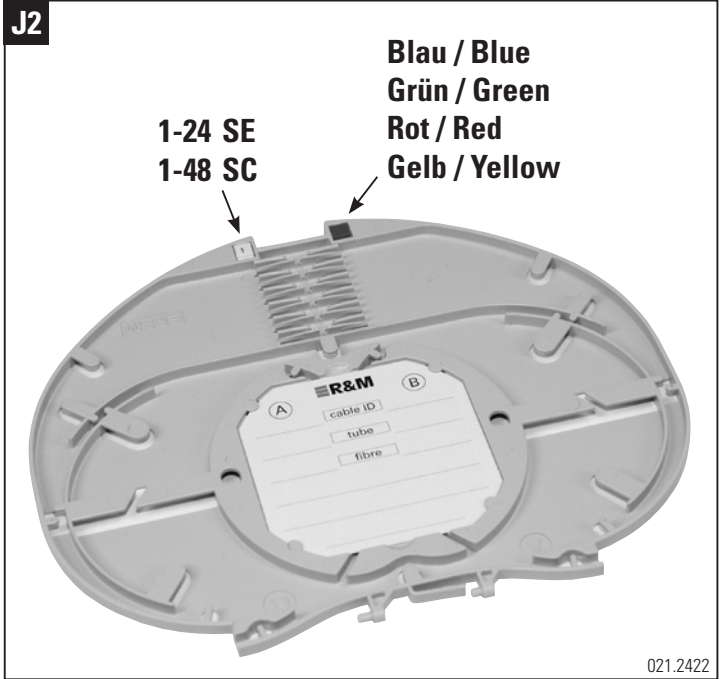
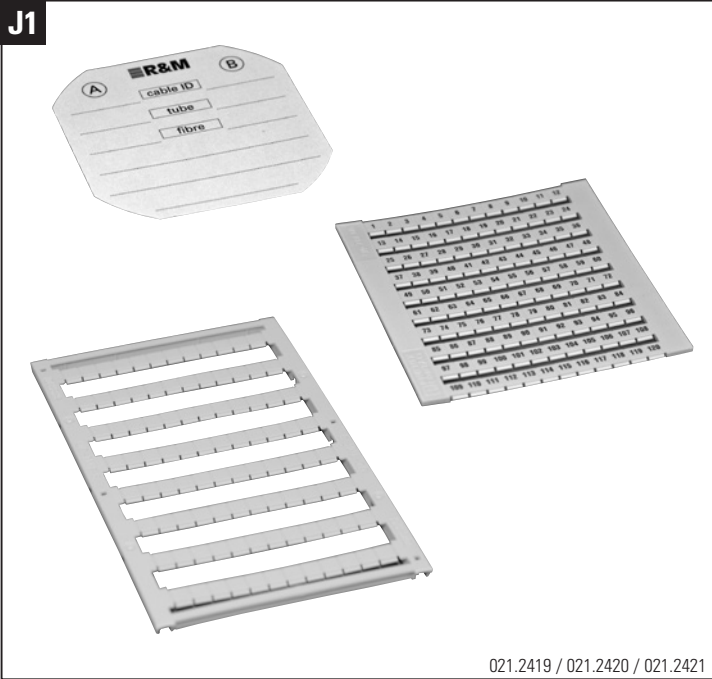



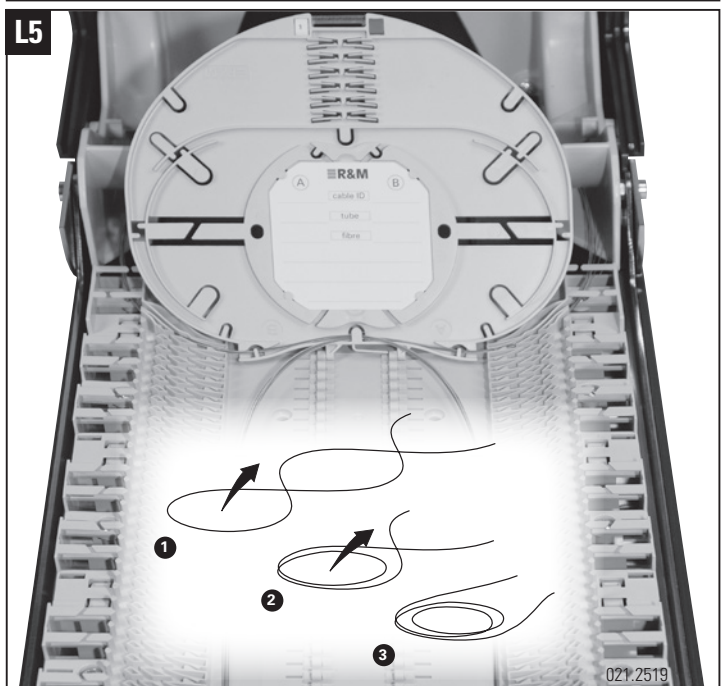
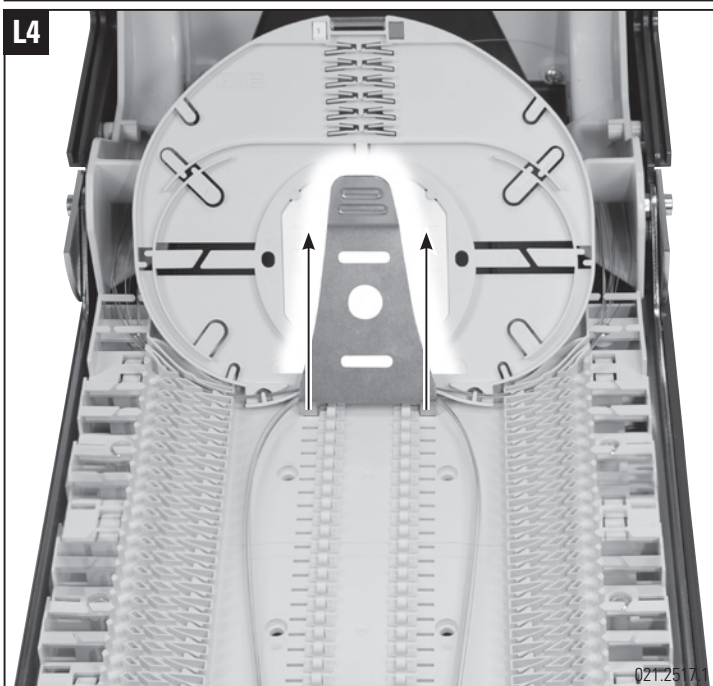
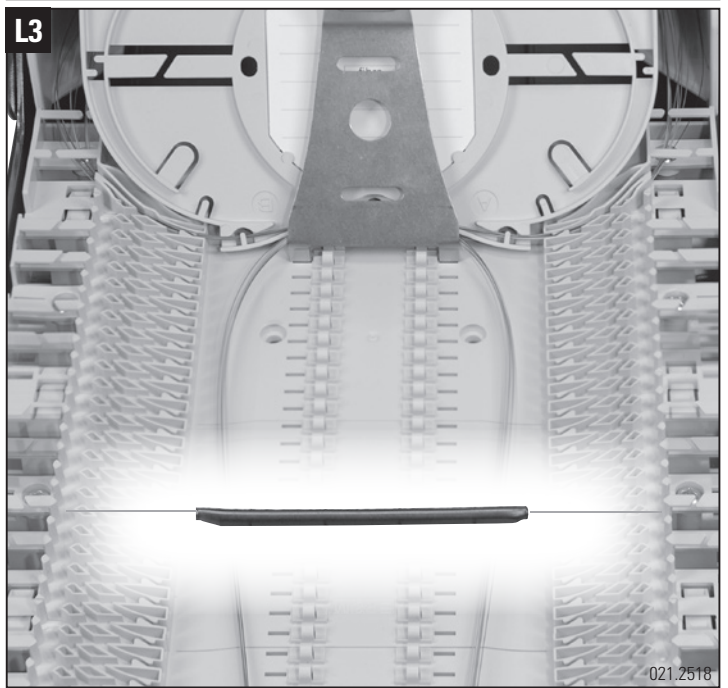
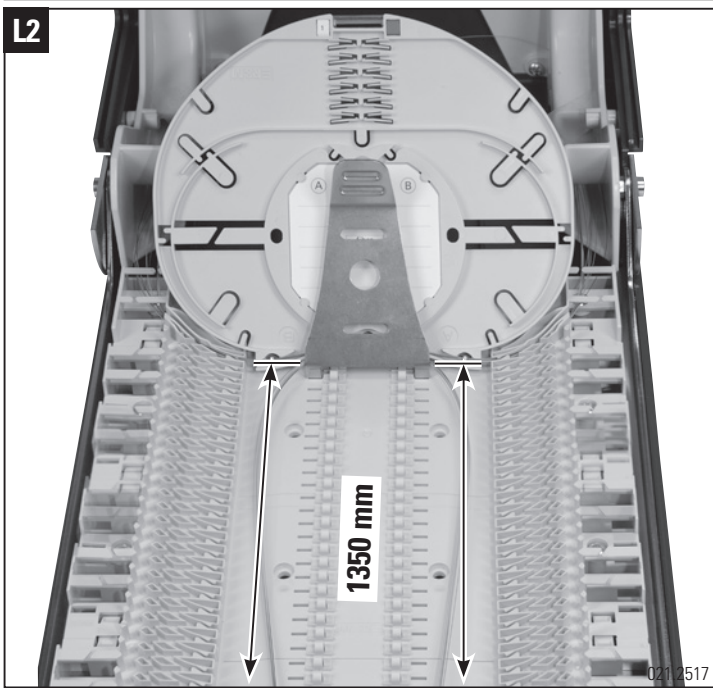
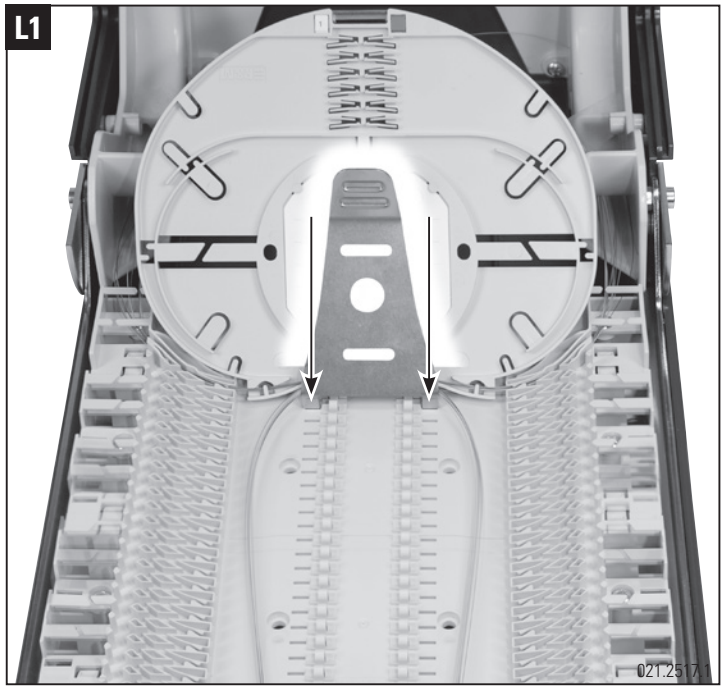
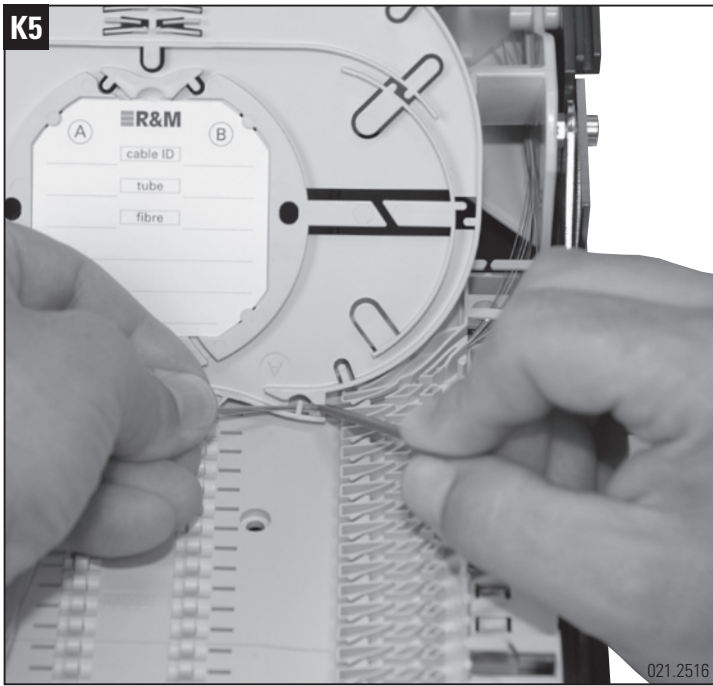

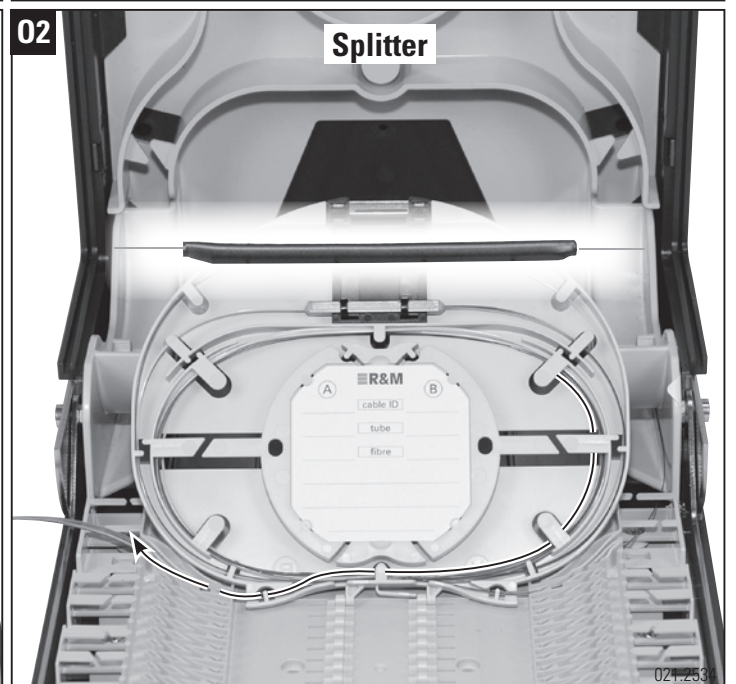
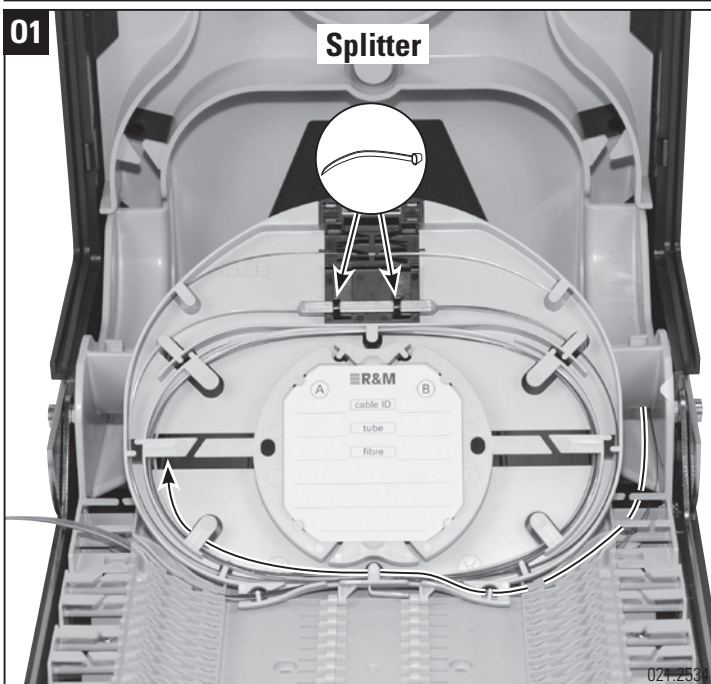
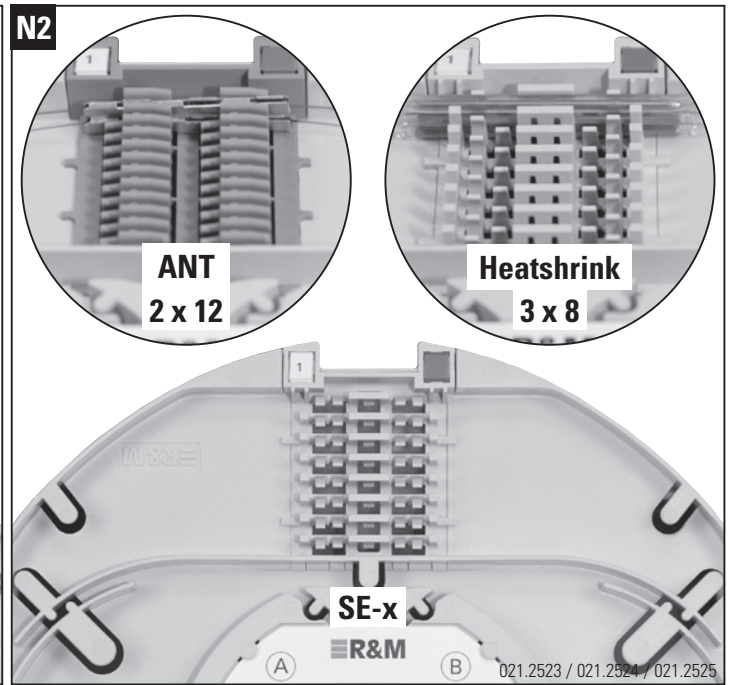
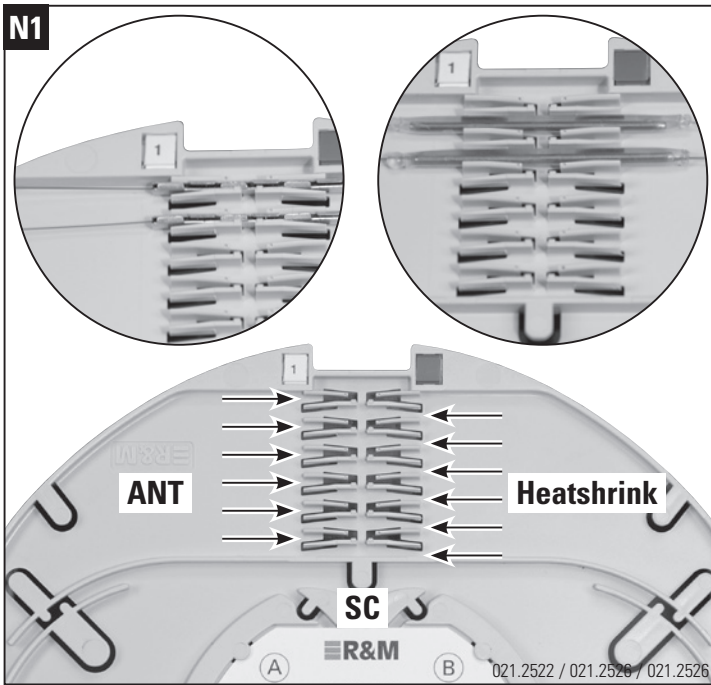
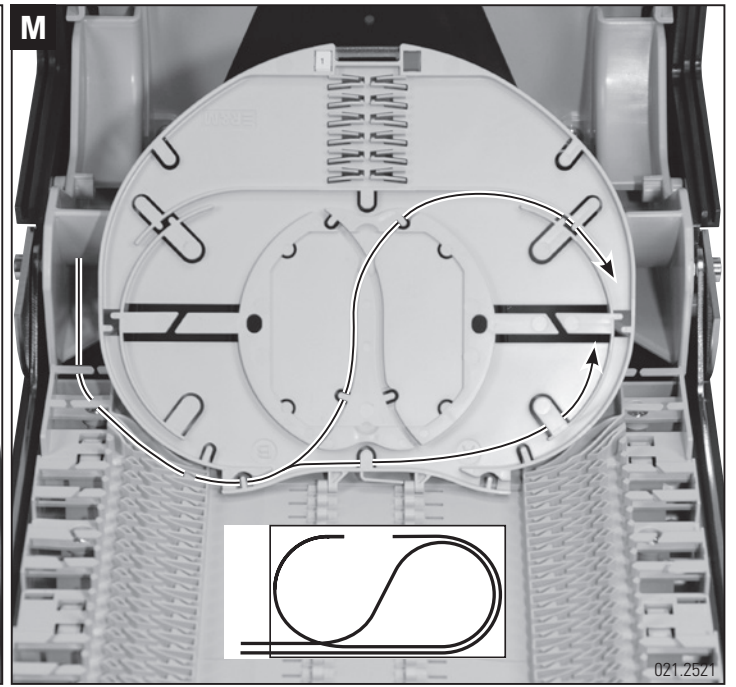
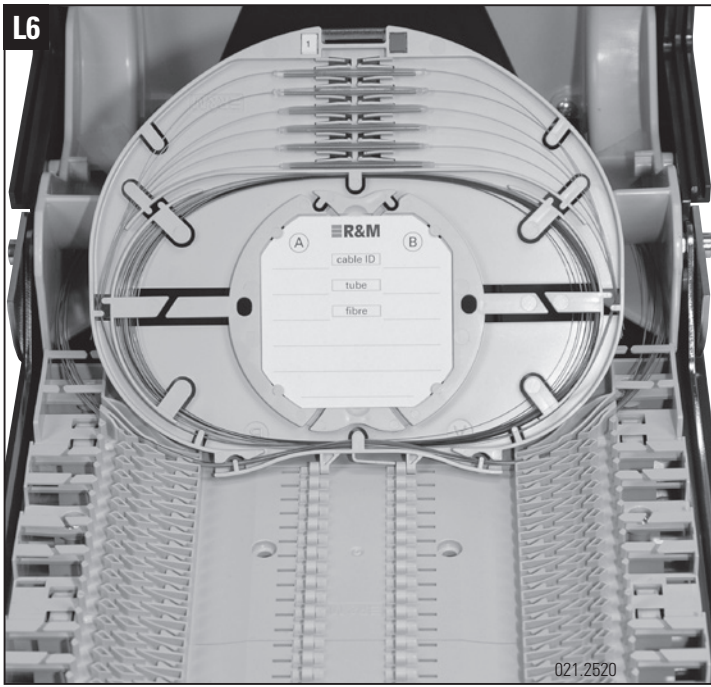

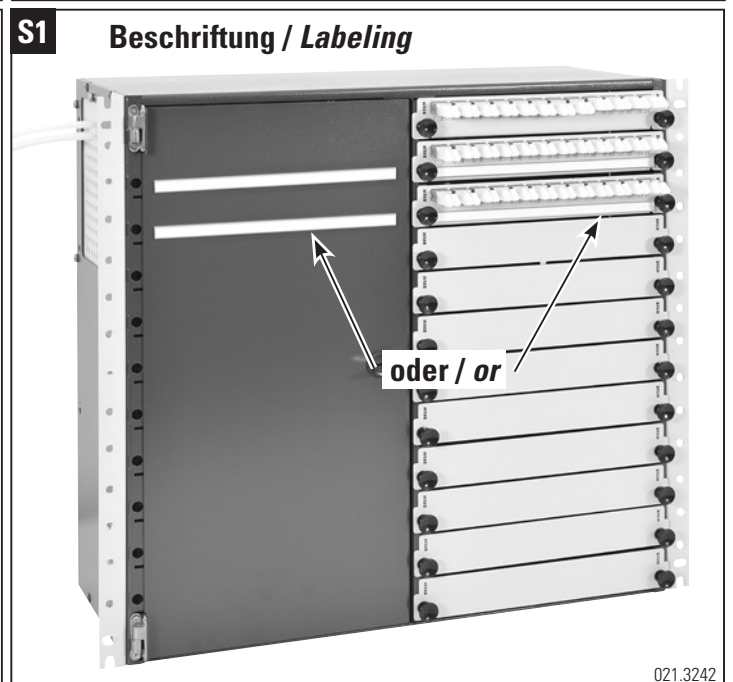
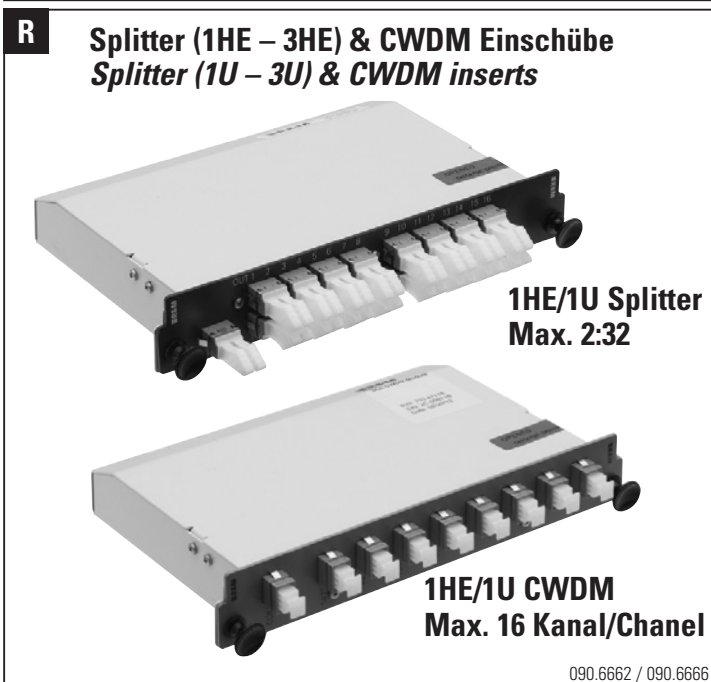
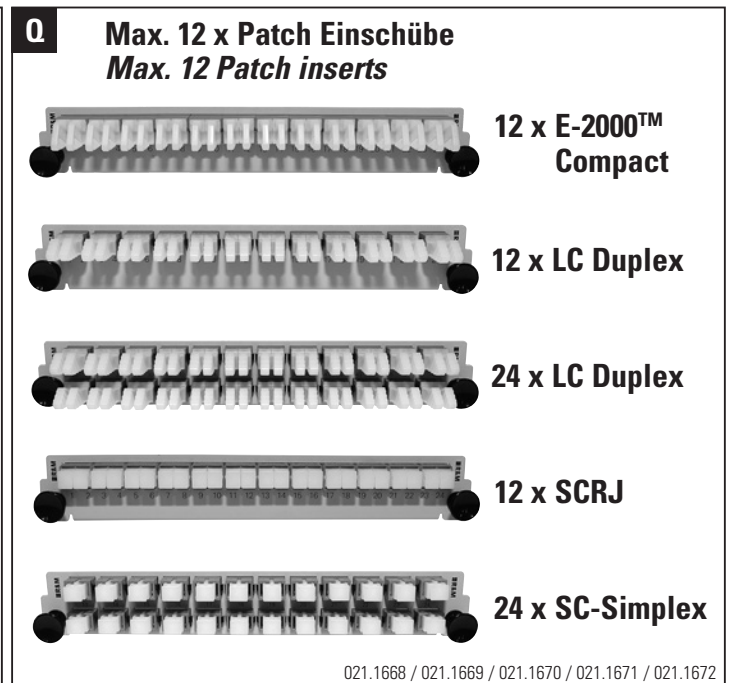
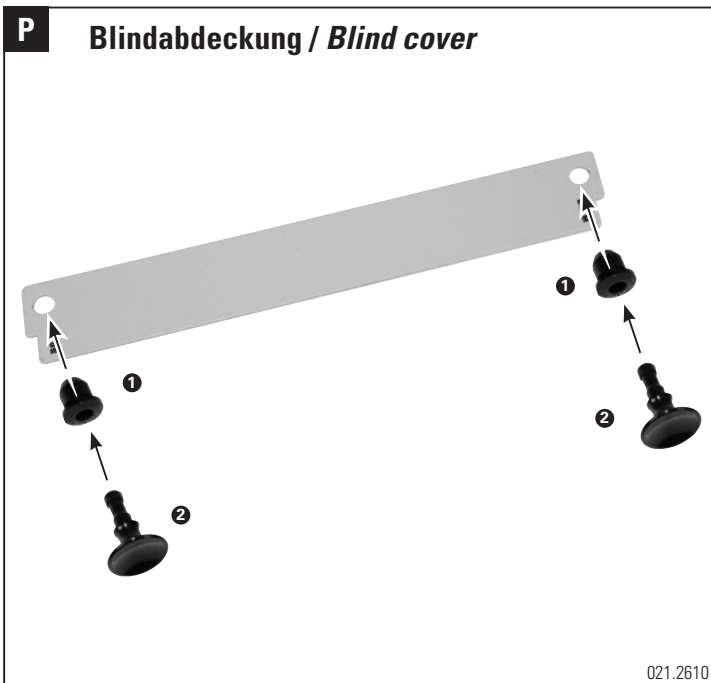
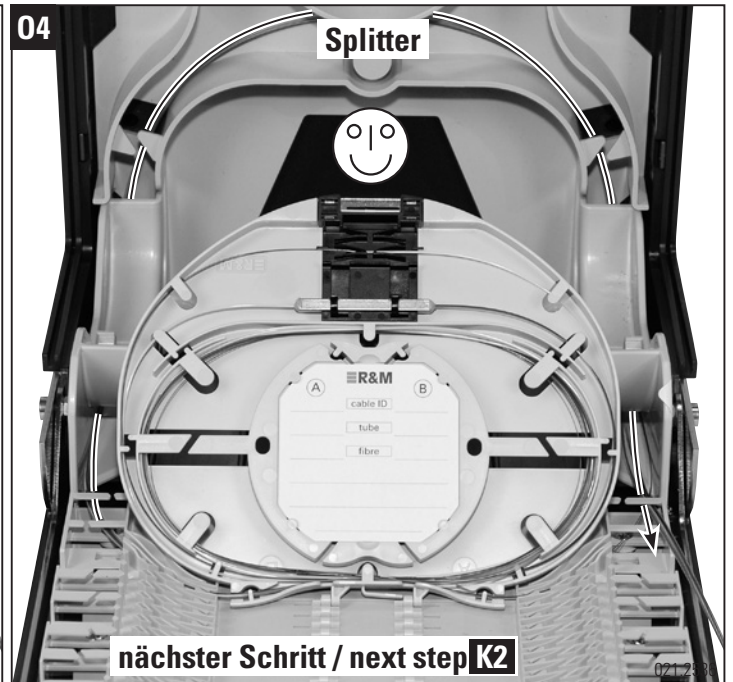
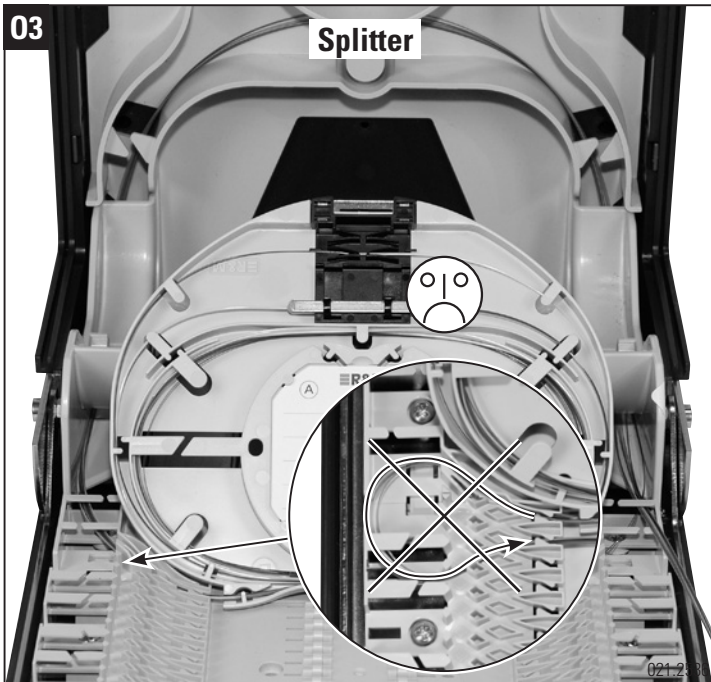

**S2** **Position für Beschriftung**  
*Position for labeling*

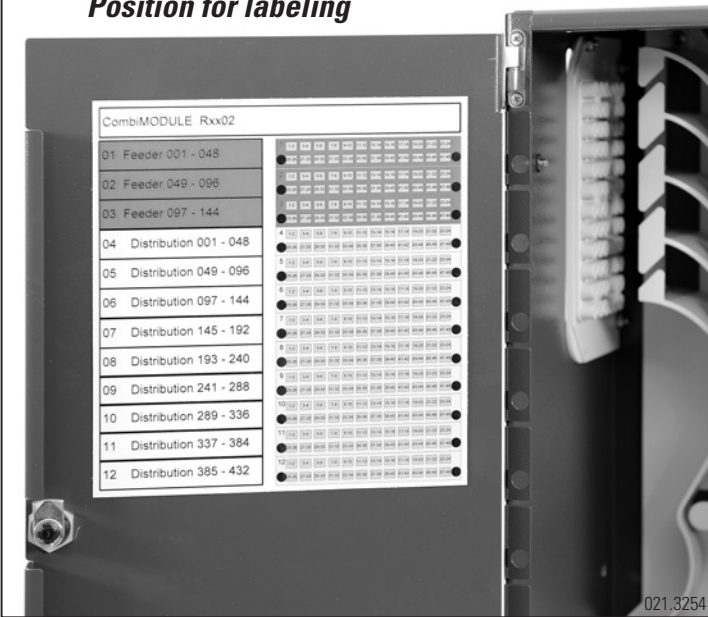

021.3254

**S3** **Nummerierung für Patch Einschübe**  
*Numbering for patch inserts*

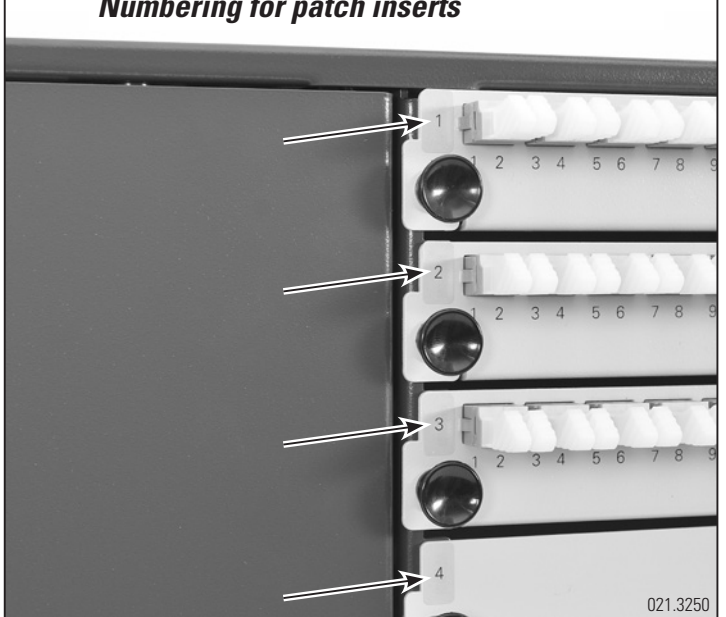

021.3250

**T1** **Service**

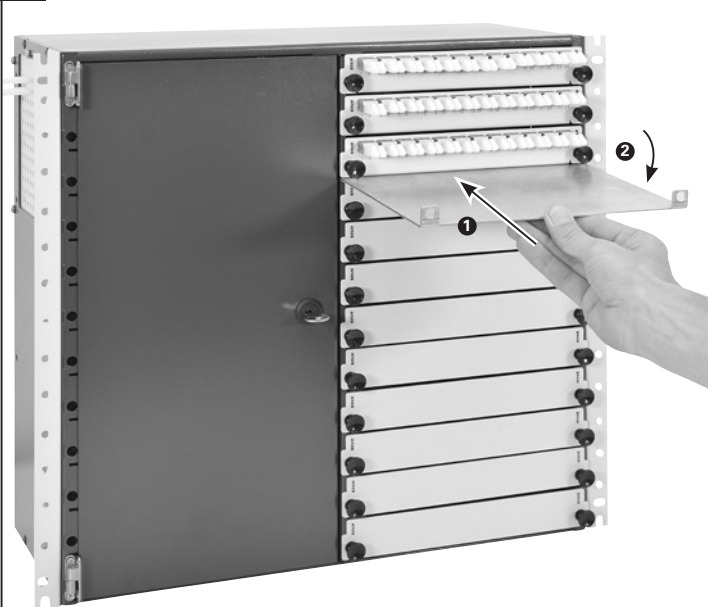

021.3225

**T2** **Service**

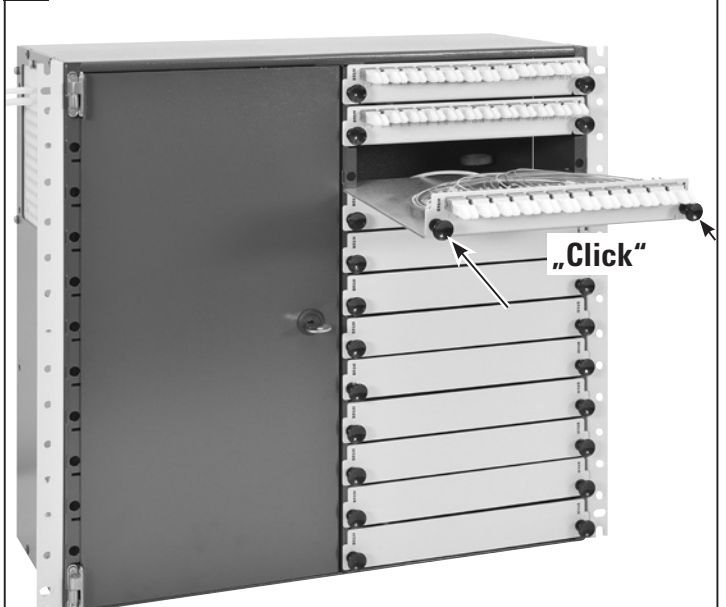

021.3224

**Headquarters**

**Switzerland**

Reichle & De-Massari AG

Binzstrasse 32

CHE-8620 Wetzikon

Telephone HQ +41 (0)44 933 81 11

Telefax HQ +41 (0)44 930 49 41

E-Mail [hq@rdm.com](mailto:hq@rdm.com)

[www.rdm.com](http://www.rdm.com)

